

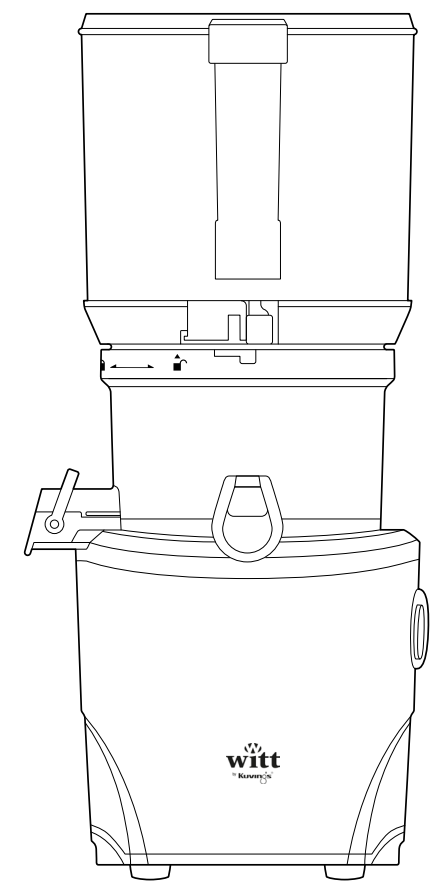



AUTO Premium Series

Kuvings Hands-Free Slow Juicer



PRODUCT INFORMATION

10EN2410388

 Do not place parts in a dishwasher, dish dryer, microwave, or under extremely hot water.

CONTENT

3 SAFETY INSTRUCTIONS

6 PARTS

8 HOW TO ASSEMBLE

10 HOW TO OPERATE

12 INGREDIENTS PREPARATION

14 HOW TO DISASSEMBLE

15 HOW TO CLEAN

16 HOW TO CLEAN SILICONE PARTS

17 OPTIONAL | HOW TO USE THE CITRUS MAKER

18 OPTIONAL | HOW TO USE THE STRAINER

19 TROUBLESHOOTING Q&A

21 SPECIFICATIONS

22 WARRANTY AND SERVICE

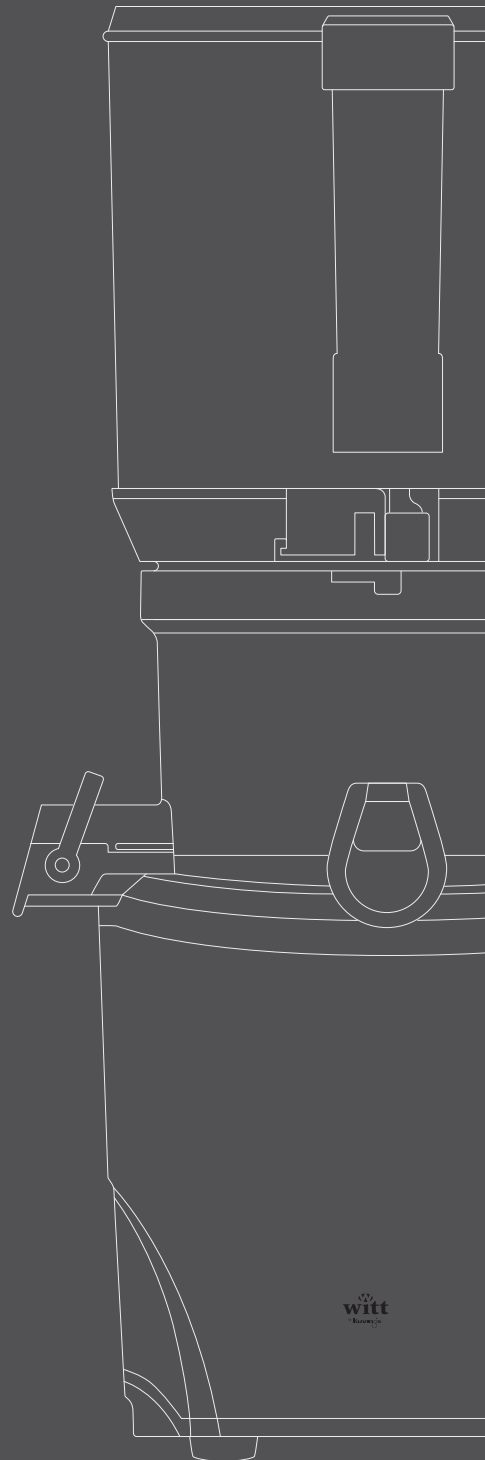

IMPORTANT SAFEGUARDS

When using electrical appliances, basic safety precautions should always be followed including the following:

- 01 Read all instructions.
- 02 To protect against risk of electrical shock, do not put motor or base of unit in water or other liquid.
- 03 Keep away from children.
- 04 Unplug from outlet when not in use, before adding or removing parts, and before cleaning.
- 05 Avoid contact with moving parts. Do not attempt to alter the parts to disable the safety interlock mechanisms.
- 06 Do not operate any appliance with a damaged cord or plug or after the appliance malfunctions, or is dropped or damaged in any manner. Contact the manufacturer at their customer service telephone number for information on examination, repair, or adjustment.
- 07 The use of attachments not recommended or sold by the manufacturer may cause fire, electric shock or injury.
- 08 Do not use outdoors.
- 09 Do not let cord hang over edge of table or counter.
- 10 To unplug the machine from an outlet, grasp the plug and pull. Never pull from the power cord.
- 11 Always attach plug to the appliance and check that the control is OFF before plugging cord into wall outlet. To disconnect, turn the control to OFF, then remove plug from wall outlet.
- 12 Make sure juicer is assembled properly before motor is turned on. Do not remove drum lid or parts while juicer is in operation.
- 13 Turn switch to OFF position after using juicer. Make sure the motor stops completely before disassembling.

- 14 Do not put your fingers or other objects into the juicer opening while it is in operation. If food becomes lodged in opening, use food pusher or another piece of fruit or vegetable to push it down. When this method is not possible, turn the motor off and disassemble juicer to remove the remaining food.
- 15 Do not use the appliance if the rotating stirrer is damaged.
- 16 Make sure the juice cup and pulp cup are always in place before operating juicer.
- 17 Please do not alter the appliance in any way.
- 18 Do not use the appliance for anything other than its intended purpose as described in the manual.
- 19 This appliance should be used for the recommended use time.
- 20 This appliance is not intended for use by persons (including children) with reduced physical, sensory, or mental capabilities, or lack of experience and knowledge, unless they are closely supervised by a person responsible for their safety. Children shall not play with the appliance. Cleaning and user maintenance shall not be made by children without supervision.
- 21 Do not use or store the appliance near a heated oven or stove.







SAVE THESE INSTRUCTIONS

- This appliance is for household use only. Please carefully follow the instructions in the manual.
(The appliance cannot be covered under the manufacture warranty if the product is abnormally or commercially used.)
- Save the instruction manual for future reference.
- If the appliance is given away as a gift, please include the manual with the product.
- These instructions must also be available in another format, for example, at www.witt.dk.

WARNING









Warns risk of death or severe injuries.

 Prohibited
  Must take action
  Do not disassemble
  Follow instruction

-  Do not plug multiple power cords on a single outlet during operation.
It may cause an explosion or fire.
-  Do not touch the power cord with wet hands.
It may cause electrical shock.
-  Do not leave the appliance unattended.
Unplug the power cord from the outlet when not in use.
-  Use a dry towel to clean the power cord if it is dirty or wet.
It may cause electrical shock or fire.
-  Do not drop the appliance nor inflict strong force to the appliance.
It may damage or break the appliance.
-  Do not unplug by pulling off the power cord cable.
It may damage the power cord and cause electrical shock
-  Do not insert your finger or other objects into the feeding tube while it is in operation.
It may cause injury.

CAUTION

Warns risk of injuries or appliance damage.

-  Do not place the parts in the dishwasher or hot water above 40°C.
The parts may wear faster.
-  Do not repair, disassemble the base, or customize the appliance.
The appliance may not operate properly causing fire, electrical shock or injury.
-  Do not use the appliance on an uneven surface.
It may cause a malfunction if the appliance tips over.
-  Keep away from children and store the appliance in a safe place.
It may cause injury.
-  Please do not store or operate the appliance near any heating appliance.
The appliance may become discolored or deformed.
-  Do not use any hazardous chemical to clean the appliance or flammable sprays near the appliance.
It may change the color of the appliance or could result in a fire.
-  To protect the power cord, please do not aggressively bend or put heavy object on top of the power cord.
It may cause short circuit or even fire.
-  Operating the juicer without ingredients can cause damage to the screw.
-  For cleaning parts that come in contact with food, please follow the instruction on pages 15-16.

PARTS

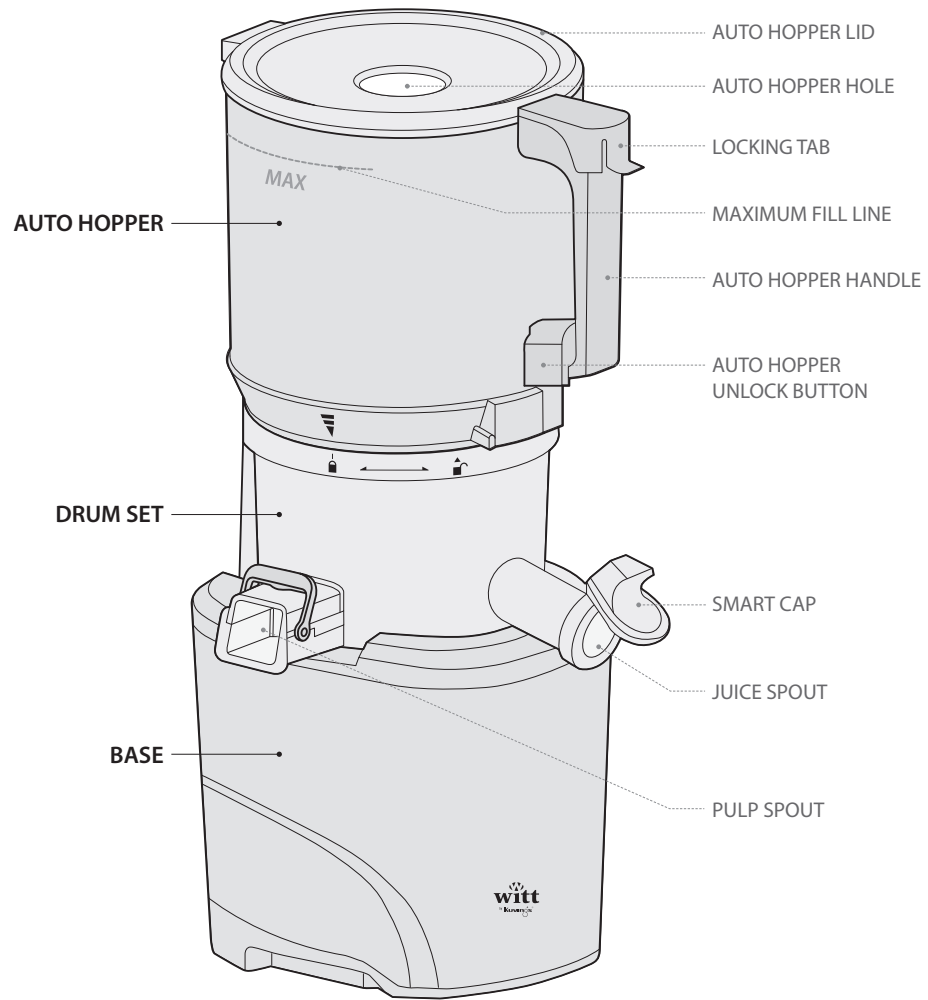

AUTO HOPPER

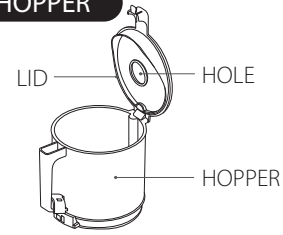

BASE

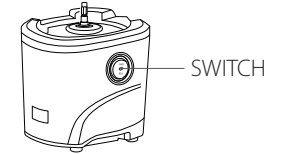

BASIC

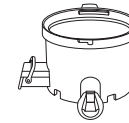

JUICING BOWL



ROTATING STIRRER



JUICING STRAINER



JUICING SCREW



JUICE CUP



PULP CUP



PUSHER



BRUSH

HOW TO ASSEMBLE

STEP 1 Drum Set

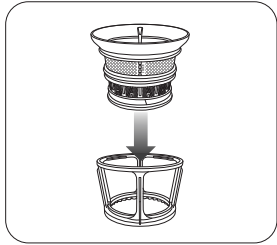

01

Completely insert the juicing strainer into the rotating stirrer.

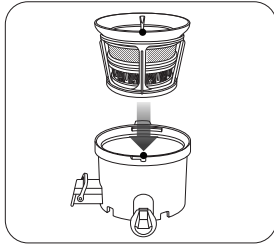

02

Place a strainer into the drum ensuring the red dot on the strainer is aligned with the red dot on the drum.

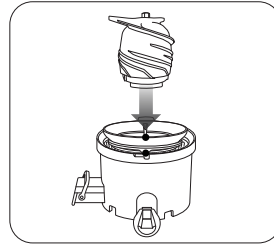

03

Gently press the screw into the center of the strainer.

⚠ If the screw is not completely tightened, the auto hopper cannot be fastened.

STEP 2 Drum set & Auto hopper

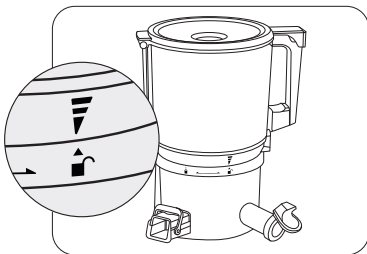

04

Place the auto hopper onto the juicing bowl aligning the ▼ sign on the auto hopper with the unlock mark ▲ on the drum.

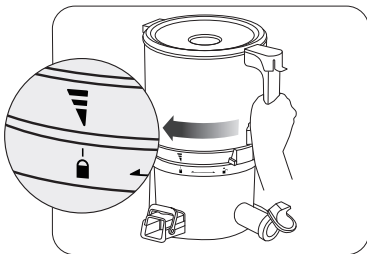

05

Turn the auto hopper clockwise until the ▼ sign on the auto hopper is lined up with the lock mark ■ on the drum.

STEP 3 Base & Top set

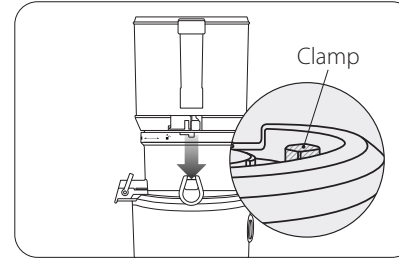

06

Place the assembled top set on the base clamp in an aligned way.

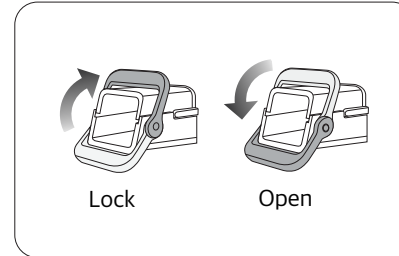

07

Make sure the pulp outlet lock is assembled.

⚠ The pulp outlet lock can be rotated up to lock or downwards to unlock.

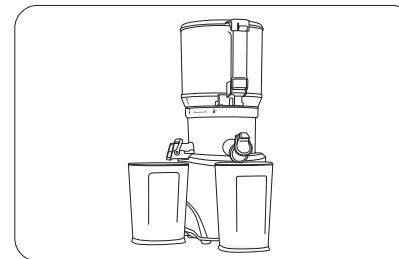

08

Place the pulp cup under the pulp spout and place the juice cup under the juice spout as shown in the illustration.

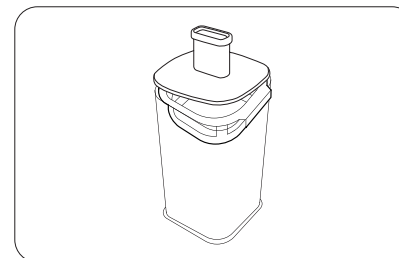

09

According to your preference, it is used for filtering the pulp. Place the pulp mesh on top of the juice cup as shown in picture.

HOW TO OPERATE

- NOTE**
- [FORWARD (FWD)] Perform the juicing of the ingredients.
 - [STOP(O)] Stop the operation.
 - [REVERSE(REV)] Return the ingredients upwards.

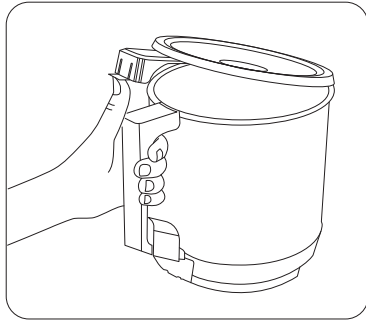

01

Open the auto hopper lid using the locking tab, and insert the ingredients.

* Refer to Insertion guide: 12P~13P

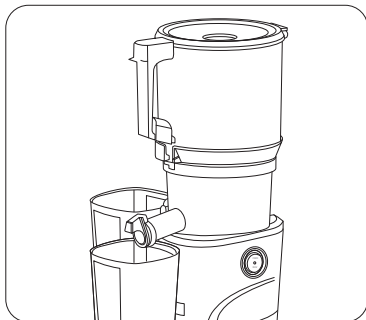

02

Press the locking tab all the way down and completely close the auto hopper lid, and then put the juice cup and pulp cup in place aligned with the outlet.

⚠ If the auto hopper lid is not completely closed, the product will not work.

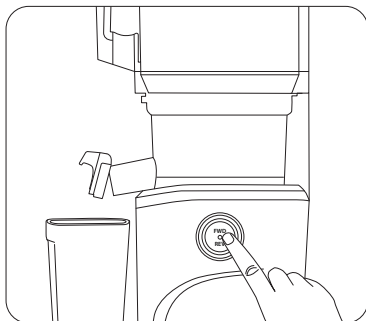

03

Press the [FWD] switch to start operation.

⚠ Keep the smart cap open. If the smart cap is closed during extraction, the juice may flow backwards.

- NOTE**
- If the product stops during use, set the switch to [STOP (O)], stop the operation completely, and return the ingredients upwards with the [REVERSE(REV)] switch.
 - The [REVERSE(REV)] switch works only while it is pressed, Hold the REVERSE button for 2-3 seconds and release.

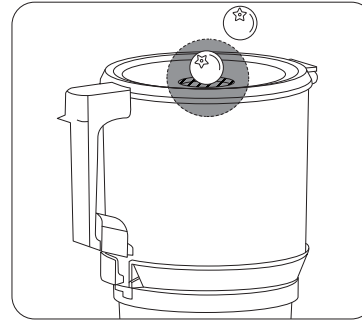

04

Add ingredients through the auto hopper hole in the hopper while the machine is ON.

⚠ If the Auto Hopper Lid is opened and ingredients are feeding in, the operation will stop.



05

Run the product until the pulp is completely drained.

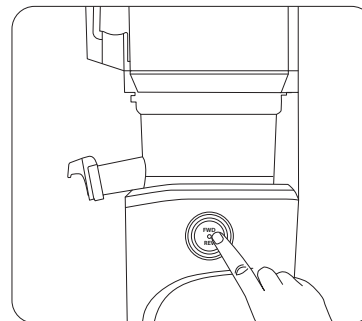

06

Set the switch to [STOP(O)] and stop the operation.

INGREDIENTS PREPARATION

- NOTE**
- Do not feed ingredients over the maximum capacity line.
 - Juicing soft & hard ingredients altogether increases efficiency.

* Large ingredients can be inserted in whole, using the large-capacity size Auto Hopper of 3,000cc class, but it is possible to extract the juice in the optimal way by cutting it into an appropriate size and inserting it.

INGREDIENTS

Fruits and Vegetables

Cut the ingredients into an appropriate size to fit in the auto hopper. Hard seeds must be removed before extraction.

ex) apple, peach, tomatoes, nectarines, apricot, plum, etc.

Leaf/stem vegetables

Cut leaf/stem vegetables with a lot of fiber, into 2~3 inches (5cm~7.6cm) or less before feeding.

ex) Kale, cabbage, celery, etc.

⚠ When a whole size of ingredients containing a lot of fiber is inserted, the ingredient may wind around the screw.

Root vegetables

Peel the skins and cut the ingredients an appropriate size to fit in the auto hopper. For long ingredients, cut them vertically for extraction.

ex) carrots, beet, ginger

Thick-skinned fruits

Peel the skins from the ingredients and cut the ingredients into an appropriate size before juicing. Hard seeds must be removed before extraction.

ex) oranges, melons, mango, pineapple, dragon fruit.

⚠ INGREDIENTS THAT REQUIRED TO CARE WHEN HANDLED

POMEGRANATE: Add only the kernels after peeling.

GRAPES: Insert just grapes only, not stems. slowly insert ingredients through the auto hopper hole.

GINGER, KOHLRABI : Cut it by 1 inches of width or less, before feeding. Do not juice the above ingredients by itself. Add only a small amount with the moist ingredients.

ALMONDS, BEANS, WALNUTS, PINE NUTS, ETC. : Soak ingredients in the water for at least 8 hours before juicing. Insert small amount with the liquids. Add ingredients through the auto hopper hole in the hopper.

- NOTE**
- When juicing mixed ingredients, put in soft ingredients and stringy ingredients first and then put in hard ingredients such as carrots and beetroot to juice more effeciently.

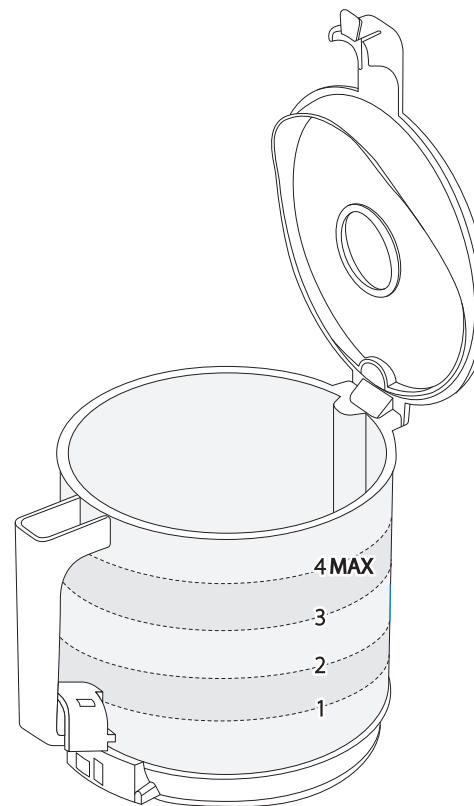

4 HARD

Carrot, beet

3 SEMI-HARD

Apple, peach, cucumber, celery

2 SOFT

Pineapple, melon, watermelon

1 LEAFY

Kale, cabbage

⚠ DO NOT INSERT THE FOLLOWING INGREDIENTS INTO THE JUICER

SESAME SEED, BUTTER, MARGARINE, ETC.

Do not extract ingredients containing vegetable or animal oil.

COCONUT, SUGARCANE, ETC.

Do not extract extremely fibrous or dry ingredients.

ICE

Do not use ice.

QUINCE, BANANA, ETC.

Do not extract ingredients with low moisture or no moisture.

HOW TO DISASSEMBLE

AUTO HOPPER & BASE

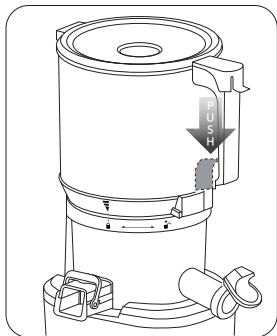

01

Press the handle switch.

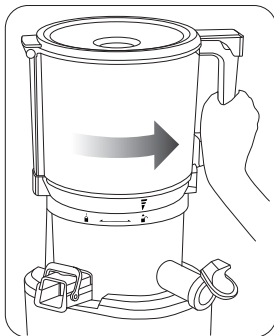

02

Open the auto hopper by turning the handle counterclockwise while pressing the handle switch.

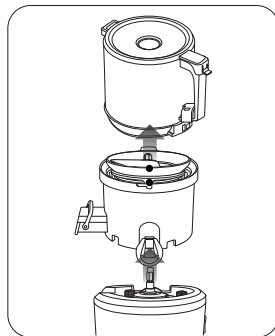

03

Lift the auto hopper and drum set in sequence and separate them from the base.

DRUM SET & BASE

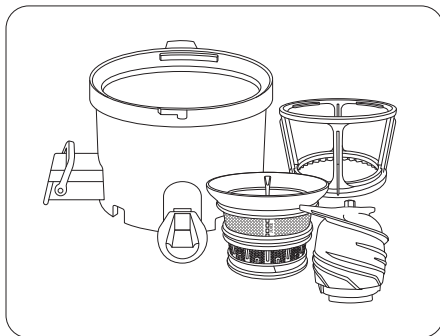

04

Separate the juicing strainer, rotating stirrer and screw from the drum set.

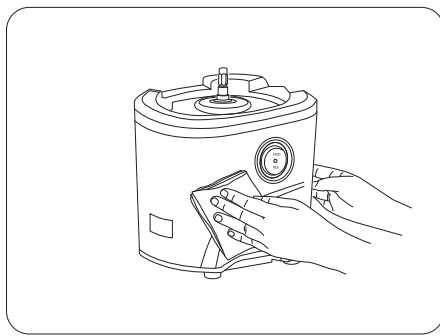

05

Wipe the base with a soft cloth containing a little moisture.

⚠ The base cannot be washed with water, so wipe it with a cloth containing a little moisture.

HOW TO CLEAN

⊘ Do not place parts in a dishwasher, dish dryer, microwave, or under extremely hot water.

NOTE Wash each part thoroughly under running water. Except the base, all parts can be washed with water.

JUICING BOWL

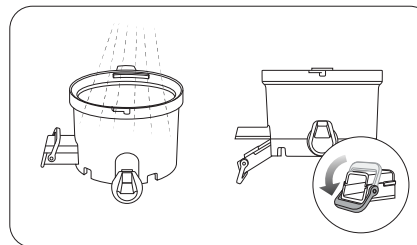

Pull the pulp outlet lock down to unlock for cleaning.

JUICING SCREW

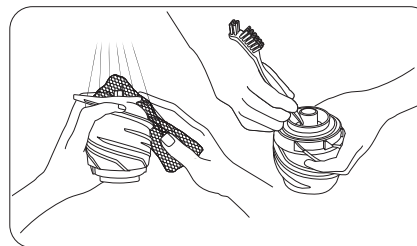

Remove foreign substances (seeds, grains) stuck in the screw groove with the tip of the cleaning brush.

⚠ If the seeds remain in the groove, the screw may break, so washing should be in completely clean state.

ROTATING BRUSH

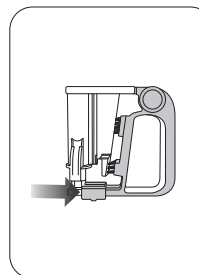

Push the slide lock of the rotating brush toward the handle to release it.

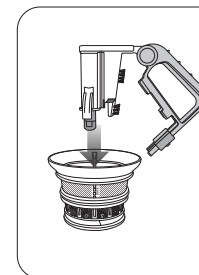

After inserting the fastening bar into the silicon ring groove in the center of the strainer, then lower the handle.

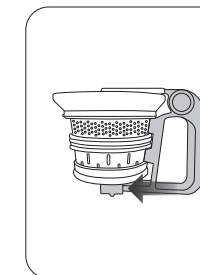

In that state, push the slide lock at the bottom with the strainer and tighten it.

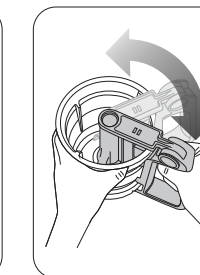

Wash from side to side while rotating brush and strainer in opposite directions under running water.

HOW TO CLEAN SILICONE PARTS

- NOTE**
- Silicone parts can be separated and assembled.
 - The silicone parts should be dried after washed and stored.
- CAUTION**
- Make sure that the silicone parts are properly inserted before assembling.
 - * If the silicone part is not completely inserted, the amount of undiluted juice solution may be less, or the undiluted solution may flow out.

SILICONE PARTS

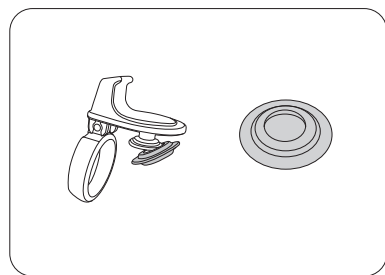

Smart Cap Silicone

Remove the smart cap silicone from the smart cap and wash it.
 * After washing, insert silicone into the smart cap before use.

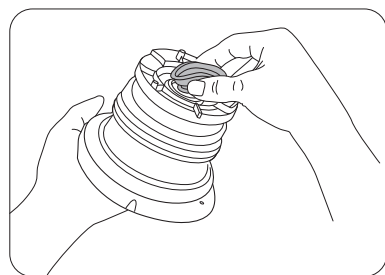

Silicone Ring

Remove the Silicon ring from strainer to clean. After cleaning, push in the silicone ring.

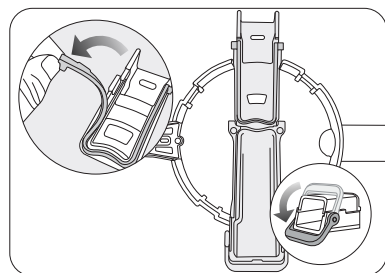

Pulp Outlet Silicone

Pull the silicone from the drum and wash it. The pulp outlet silicone is connected to the drum and cannot be separated completely.

- ⚠ After washing, Insert the silicone completely into the groove.
- ⚠ If the silicone part is not completely inserted, the amount of undiluted solution may flow out.

OPTIONAL | HOW TO USE THE CITRUS MAKER

- NOTE** Cut the fruit in half for juicing. The amount of resulting juice may vary depending on the ingredients used.

HOW TO ASSEMBLE

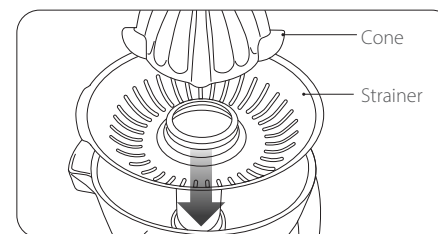

01

Assemble the citrus maker by inserting the strainer and cone into the center of the citrus maker drum.

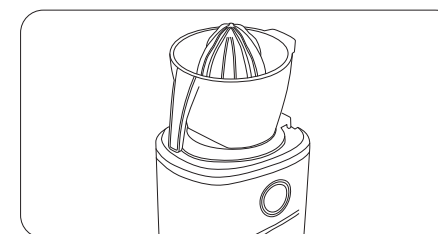

02

Place the assembled drum set onto the base to use.

HOW TO OPERATE

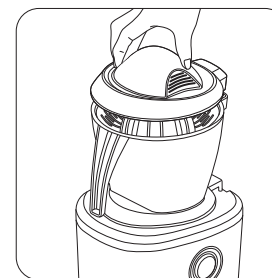

01

Open the lid after placing the citrus maker on the base.

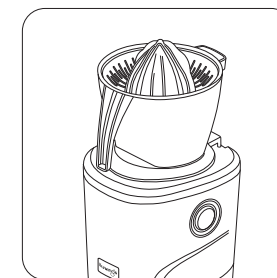

02

Press the FWD button to start the citrus maker.

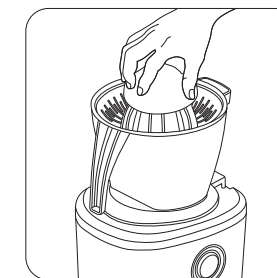

03

Cut the fruits in half and press them gently on the cone. (The motor rotates the cone to extract the juice.)

OPTIONAL | HOW TO USE THE STRAINER

NOTE Be sure to check that silicone parts are properly inserted before use.

CAUTION Remove the seeds and skins from ingredients having hard seeds or thick skins before use. It is recommended to cut the ingredients into small pieces and freeze them.

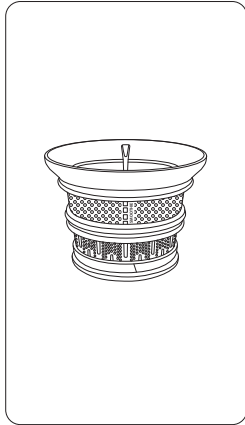

Smoothie Strainer

Ingredients : Frozen fruits (strawberry, mango, etc.), liquids (milk, water, etc.)

Precautions : Allow the frozen items to thaw for 5 to 20 minutes before use. Close the smart cap. Turn the juicer on and add the liquid first. Slowly insert small amounts through the auto hopper hole.

* We recommend a 1:1 ratio between frozen ingredients and liquid.

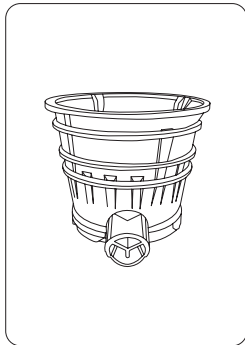

Blank Strainer

Ingredients : Frozen fruits (strawberry, pineapple, mango, etc.)

Precautions : Blank Strainer is only for frozen ingredients. Allow the frozen items to thaw for 5 to 10 minutes before use. Slowly insert small amounts through the auto hopper hole.

* Always leave the smart cap open.



Coarse Strainer

Ingredients : Fruits (strawberry, blueberry, pineapple, mango, etc.)

TROUBLESHOOTING Q&A

When there is no power

- Check if the power cord is properly plugged in.
- Check if the drum lid and the juicing bowl are properly assembled.
- Check if the top-set and the body are properly assembled.

* Juicer will not operate if parts are not properly assembled and if the arrows are not aligned.

Low juice yield

- Different ingredients produce varying amounts of fluid that will yield different amounts of juice.
- If the ingredients are not fresh, they may contain reduced amount of fluid, which will yield less juice. Soak ingredients in cold water for about 30 mins prior to juicing for the best results.
- If the ingredient itself has low water content, it may help to soak it in water before juicing.
- If juicing ingredients with small seeds, after a few servings, it may reduce the juice yield. For best result, disassemble and wash the top-set in between juicing.

* If there is seed residue on the bottom of the strainer, this can affect juicer's performance and the overall juice yield.

Too much pulp in juice

- Cutting down fibrous foods into smaller pieces and juicing them at a slower pace can reduce pulp buildup inside the juicer.
- If the strainer and the screw are damaged and affecting the juicer's performance, it is recommended the parts be replaced.

* The lifetime of each part may vary depending on length and method of use and ingredients extracted.

The auto hopper will not close

- Make sure the juicing screw is pushed all the way into the strainer in order for the drum lid to close properly.

* If the juicing screw is not properly in position, the auto hopper may not close.

Noise from the juicer

- Check if the parts are assembled correctly. Try to reassemble the parts and check for noise.
- Do not run the juicer without any ingredients.
- * Operating the juicer without ingredients can cause damage to the screw.
- If the juicer is operated without any ingredients or liquid, the noise can be loud, and it can cause the damage
- The friction noise from the juicing screw and the strainer will disappear when ingredients are inserted into the juicer.
- If the noise occurs when ingredients are inserted into the juicer, check the size of the ingredients. Do not insert any hard ingredients that are more than 1 inch thick.

* The noise can occur if the juicer is operated on an uneven or slanted surface. Place the juicer on a horizontally flat surface when operating.

The extracted pulp is very moist

- During the very beginning of extraction, the pulp can be more moist.
- There may be pulp buildup inside the juicer. Clean the parts to remove excess pulp or pieces of food that may be clogged.

During operation, the drum shakes.

- The juicing screw and the strainer are set up to crush and squeeze the ingredients. It is normal for the juicing screw and the strainer to vibrate.
- If the ingredient contains strong fiber, the vibration from the top-set may be stronger.

TROUBLESHOOTING Q&A

During juicing, the motor stopped

- Check the power cord and make sure it is plugged in correctly.
- Check that all the parts are correctly assembled.
- If too many ingredients are inserted at one time, this can cause the juicer to stop.
- When the juicer stops because there are too many ingredients inserted in it, press the REVERSE - OFF - FORWARD button in this order, switching back and forth 2 to 3 times.
- The reverse setting will push the ingredients up, and the forward setting will pull the ingredients down.
- After using more than 30 minutes continuously, the overload protection feature may stop the juicer. Let the juicer cool for 30 minutes to 1 hour before juicing again.
- If there are hard seeds within the ingredients, remove them before juicing. Hard seeds can damage the juicer.

Layer separation of juice

- Depending on the density of the ingredients, the extracted juice may show layers of different juices. It is different from separation due to oxidation caused by juicing with a high-speed juicer.

The auto hopper is stuck

- After juicing, let the juicer operate for another 30 seconds to extract the remaining pulp.
- If there is too much pulp in the top-set, this can cause the auto hopper not to open. In this situation, press the REVERSE-OFF-FORWARD button in the order, switching back and forth 2 to 3 times.

Juice dripping down the body

- If the silicone parts on the bottom of the pulp outlet are not plugged in correctly, the juice may seep out on to the juicer body. Before assembling the parts, make sure the silicone parts are plugged in correctly.

Is it possible to juice ingredients with tough fiber?

- Ingredients like celery or ginger contain long fibers that may wrap around the juicing screw and affect the juicer's performance. When juicing fibrous ingredients, cut them down to smaller pieces and alternate with other ingredients. Clean the top set regularly if juicing larger amounts of fibrous produce.

Plastic parts are discolored

- After juicing, if the juicer is not cleaned right away, the remaining pulp inside the top-set can dry up which can make disassembling and cleaning hard. This can also affect the juicer's performance and color.
- Ingredients that are rich in carotenoids such as carrots and spinach may dye plastic parts. When the parts are dyed with carotenoids, rub vegetable oil or lemon juice into the dyed areas and use mild detergent to clean.
- Vegetable oil should only be used during clean-up for parts that are discolored. Do not use vegetable oil on the juicing screw or the strainer. If vegetable oil or oil from animal fat gets on the juicing screw or the strainer, this can affect the juicer's performance and may result in damaged parts.
- The silicone pieces on the top-set can be detached to be thoroughly cleaned.

Using for different purposes

- This juicer is designed for home use to juice ingredients like fruits, vegetables, soaked nuts, and soaked soybeans.
- Do not use the juicer for extracting oils or butters.
- Do not juice ingredients with high contents of vegetable/ animal oil.
- If vegetable/animal oil gets on the juicing screw or the strainer, this can affect the performance of the juicer and could result in damaged parts.

SPECIFICATIONS

Witt Auto Premium Series

Product	Juicer
Model	KHS-2571CE
Voltage	AC220-240V, 50/60Hz
Power Consumption	200W
Maximum Use	Less than 30 min
Weight	7.5kg
Dimension	207x254x459 mm
Manufacturer	NUC Electronics Co., Ltd.
Type	Low speed compression
Origin	Made in Korea

WARRANTY AND SERVICE

There is a 2-year warranty period if your new product stops working due to manufacturing or material faults which begins from the documented date of purchase. The warranty covers materials and the cost of labour. When inquiring about service, please state the product name and serial number. You can find this information on the type plate. You can write down the information here in these instructions so that you have them at hand. This makes it easier for the service technician to find the correct spare parts.

The warranty does not cover:

- Faults and damage that are not due to manufacturing or material issues
- Damage caused by failure to properly maintain the device - including failing to clean it
- Fire and/or water damage or moisture damage on the product
- Damage caused during transport if the product was transported without proper packaging
- Damage caused by the use of unoriginal spare parts
- Damage resulting from failing to follow the instructions on how to use the device
- If the device has not been set up/assembled as specified in the instructions
- If non-professionals have installed or repaired the product
- Batteries or any other parts subject to normal wear and tear

Damage during transport

If the product is damaged during transport and this is discovered when the retailer delivers the product to the customer, this is exclusively a matter between the customer and the retailer. In cases where customers have handled the transport of the product themselves, the supplier shall not be liable for any potential damage during transport. Any damage caused during transport must be reported immediately and no later than 24 hours after the product has been delivered. If not, the customer's claim will be rejected.

Unnecessary service

If the product is sent in to be serviced and it turns out that the fault could have been fixed independently by following the product's instruction manual, the customer will need to pay the service fee.

Commercial purchases

Commercial purchases are all purchases of devices that are not intended to be used in private households but instead intended to be used for commercial purposes (in restaurants, cafés, canteens, etc.) or intended to be rented out or otherwise used by multiple users in turn.

There is no warranty offered for commercial purchases, as this product is only intended for regular household use.

Service

For service and spare parts in England and Ireland please call below-mentioned number and you will be directed accordingly or send us an email.

Witt UK & Ireland Ltd.

(44) 148 351 6633 / info@witt.dk

If you want to use a service technician or get spare parts in Denmark, please contact the store that you bought the product from.

You can also claim warranty at witt.dk under the 'Service' tab.

We accept no liability for printing errors.

The manufacturer/distributor cannot be held liable for damage to products or individuals if the safety instructions were not followed. The warranty shall not cover cases where the instructions have not been followed.

